



INCONTINENCE & MEDICAL DIVISION





THE COMPANY



APOGEE group, a Belgian established business, has more than 20 years experience in providing service and products for healthcare patients in need. Thanks to the company's experience, the NATEEN®'s brand was introduced in 2009 to provide **incontinence product distribution** and **supply chain services** to healthcare providers, allowing them to deploy more time and resources into delivering **high quality and affordable** patient care. Given escalating healthcare costs, ARTEMIS's focus is on delivering to our customers the highest quality products and services at the lowest cost today, whilst meeting the ever-changing needs of tomorrow. Today NATEEN® provide products to millions of customers worldwide through partnership, thus creating a smart distribution network.

SOURCING

We source and negotiate in the global market everyday to ensure our customers receive consistently high quality materials at the best price possible.

CUSTOM

We offer a customized product range. This service concern either COBRANDING or full PRIVATE LABEL service.

LOGISTICS

Thanks to our high daily sales volumes we benefit from best freight prices which is a benefit shared with our customers.

PRODUCING

Our production team is trained to work to a high quality standard to ensure a consistent quality product.

INNOVATING

Our R&D department is constantly looking at the solution and new developments to ensure we are increasing our customer's competitiveness.

PROMOTION

NATEEN's quality is becoming more widely recognized in the industry thanks to heavy investment in promotional activities. The customer benefits from this reputed brand and quality, with personalized training services.



Environmental and social commitment is part of our profitability.









Compliance with high healthcare standard.



Attest the biocompatibility of our product. Tested in Germany.



Table of contents

	Individual protection	P 6
	Gloves	P 15
	Mask	P 17
	Bedding protection	P 19
	Airways tubing & Nebulizers	P 23
	Disinfecting towel	P 24
	Dermatological products	P 25
	Incontinence range	P 30

Individual protection

Scrub suits

Navy blue

Description

Set includes a V-neck top with short sleeves
2 patch pockets and a heart pocket, pants with shoelaces
Top and pants on the same size, packed together in a bag

Content

Non sterile, non-woven SMS, extra soft and antistatic treatments,
for single use

Weight

45gsm

Compliance

European Directive 93/42/CEE (class I)
EN13795



	Size	Ref	Packaging
◆	XS	7520	50
◆	S	7521	50
◆	M	7522	50
◆	L	7523	50
◆	XL	7524	50
◆	2XL	7525	50
◆	3XL	7526	50
◆	5XL	7527	50

Green



	Size	Ref	Packaging
◆	XS	7510	50
◆	S	7511	50
◆	M	7512	50
◆	L	7513	50
◆	XL	7514	50
◆	2XL	7515	50
◆	3XL	7516	50

Light blue



	Size	Ref	Packaging
◆	XS	7500	50
◆	S	7501	50
◆	M	7502	50
◆	L	7503	50
◆	XL	7504	50
◆	2XL	7505	50
◆	3XL	7506	50

Pink



	Size	Ref	Packaging
◆	XS	7529	50
◆	S	7530	50
◆	M	7531	50
◆	L	7532	50
◆	XL	7533	50
◆	2XL	7534	50
◆	3XL	7535	50

Parma



	Size	Ref	Packaging
◆	XS	7600	50
◆	S	7601	50
◆	M	7602	50
◆	L	7603	50
◆	XL	7604	50
◆	2XL	7605	50
◆	3XL	7606	50



Scrub suits

Navy blue scrub suit top



	Size	Ref	Packaging
◆	XS	7620T	50
◆	M	7622T	50
◆	XL	7624T	50

Individually packed

Navy blue scrub suit pants



	Size	Ref	Packaging
◆	XS	7620P	50
◆	M	7622P	50
◆	XL	7624P	50

Individually packed

Lab jackets

Description

Jacket with long sleeves and collar and cuffs in Jersey
4 snaps closure
2 patch pockets and a heart pocket

Content

Non sterile, non-woven SMS, extra soft and antistatic treatments, for single use

Weight

45gsm

Compliance

European Directive 93/42/CEE (class I)
EN13795



Jacket for the medical staff to fight against cold

Blue lab jacket

	Size	Ref	Packaging
◆	1 (S-M)	7550	50
◆	2 (L-XL)	7552	50

Green lab jacket

	Size	Ref	Packaging
◆	1 (S-M)	7550V	50
◆	2 (L-XL)	7552V	50
◆	3 (2XL-3XL)	7554V	50



Patient protection

Patient gown



Description

Patient gown with short sleeves
Completely opaque
Waist and collar laces
Bags of 10 units

Content

Non sterile, non-wooven SMS, extra soft
and antistatic treatments, for single use

Weight

30gsm

Compliance

European Directive 93/42/CEE (class I)
EN13795

	Size	Ref	Packaging
◆	Baby	7549	100
◆	Child	7541	100
◆	Adult	7540	100
◆	Large	7553	100

Dressing gown



Description

Dressing gown with three-quarter sleeves
Completely opaque
Waist laces
Bags of 10 units

Content

Non sterile, non-wooven SMS, extra soft
and antistatic treatments, for single use

Weight

30gsm

Compliance

European Directive 93/42/CEE (class I)
EN13795

	Size	Ref	Packaging
◆	Adult	7570	100

Underpants



Content

Non sterile, non-wooven SMS, extra soft
and antistatic treatments, for single use

Weight

30gsm

	Size	Ref	Packaging
◆	Adult	7030	500



patient kits

Adult standard patient kit (N°1)



Patient gown



Ref: 7540

Mob cap with clip

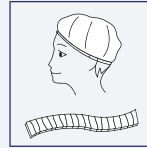

Ref: 7047

White shoe covers



Ref: 7046

Individually packed in a bag

Size	Ref	Packaging
Adult	7542	50

Complete patient kit (N°2)

Patient gown



Ref: -

Mob cap with clip

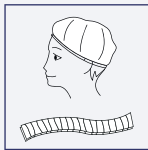

Ref: 7047

Underpants



Ref: 7030

White shoe covers



Ref: 7046

Individually packed in a bag

Size	Ref	Packaging
Child	7547B	50
Adult	7543	50
Large	7575	50

Adult shower patient kit (N°3)

Patient gown



Ref: 7540

Mob cap with clip

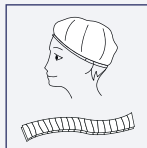

Ref: 7047

Underpants



Ref: 7030

White shoe covers



Ref: 7046

Wash cloth

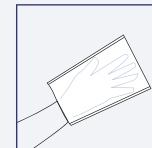

Ref: 4026

Bath towel

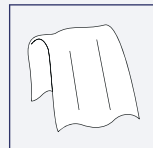

Ref: 4027

Individually packed in a bag

Size	Ref	Packaging
Adult	7544	50



patient kits

Patient kit 7571A



Parma dressing gown



Ref: -

Mob cap with clip

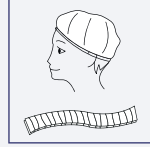

Ref: 7047

Parma bermuda shorts

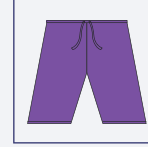

Ref: -

Slippers with shoe covers



Ref: 7074

Individually packed in a bag

Size	Ref	Packaging
Adult	7571A	50

Kit patient 7572



Navy blue dressing gown



Ref: 7570

Mob cap with clip

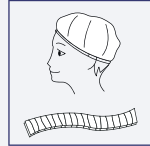

Ref: 7047

Underpants



Ref: 7030

White shoe covers



Ref: 7046

Individually packed in a bag

Size	Ref	Packaging
Adult	7572	50

Patient kit UCA2



Green shirt with Velcro closure



Ref: -

Green pants

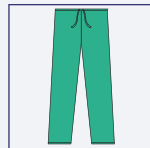

Ref: -

Mob cap with clip

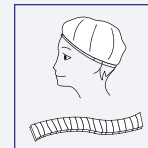

Ref: 7047

Slippers



Ref: 7079

Individually packed in a bag

Size	Ref	Packaging
Adult	UCA2	50

Patient kit 7595XL



Navy blue dressing gown



Ref: 7570XL

Patient gown



Ref: 7553

Mob cap with clip

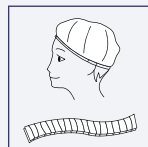

Ref: 7047

Underpants



Ref: 7030XL

Slippers with shoe covers



Ref: 7074

Individually packed in a bag

Size	Ref	Packaging
XL	7595XL	50



Customize your own kit !

Select:

- ◆ Size: Child , Adult , Large
- ◆ Colour: Navy blue , Light blue , Green , Pink , Parma
- ◆ Content: SMS 30g , SMS 45g

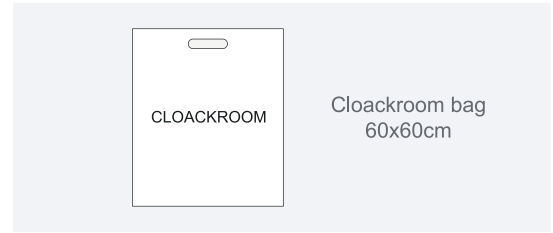

Upper body ◆◆◆◆◆



Lower body ◆◆◆◆◆



Headwear

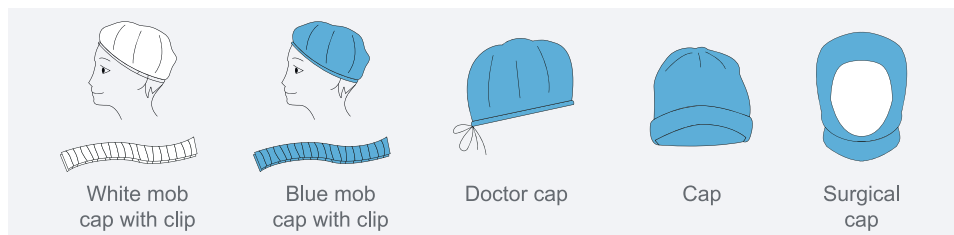

Bathing

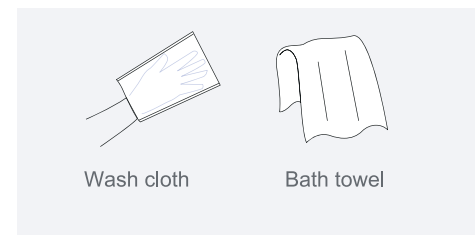

Footwear

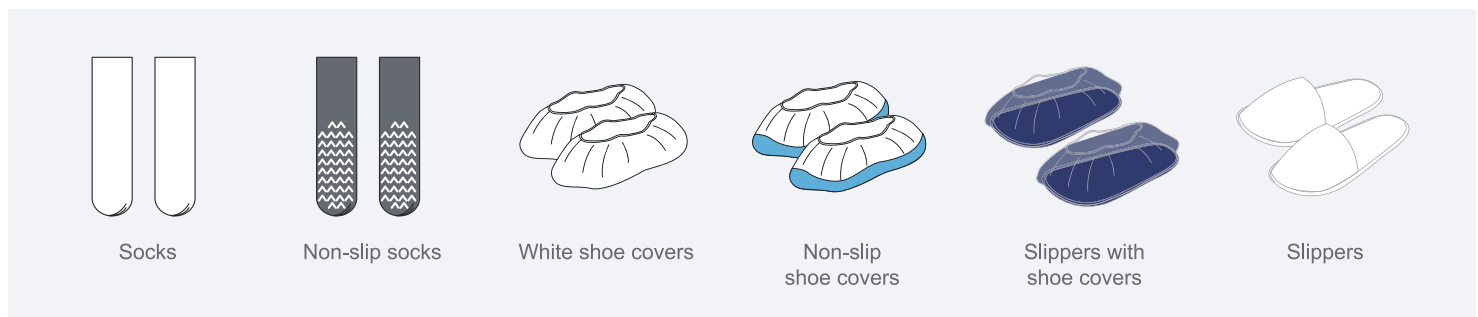

Gowns

Doctor's coat



Description: Coat with long sleeves, length 105cm, 4 snaps closure, 2 patch pockets and a heart pocket
Individually packed

Content: Non sterile non woven PP spunbond, extra soft and antistatic treatments, for single use

Weight: 40gsm

Compliance: European Directive 93/42/CEE (class I)
EN13795

Size	Ref	Packaging
1	7546	50
2	7548	50

Isolation gown



Description: Gown with long sleeves, length 115cm, elastic cuffs, waist and collar laces

Size: adult
Bags of 10 units

Content: Non sterile non woven PP spunbond, extra soft and antistatic treatments, for single use

Weight: 22gsm

Compliance: European Directive 93/42/CEE (class I)
EN13795

	Size	Ref	Packaging
◆	Blue	7555	100
◆	Green	7556	100
◆	Yellow	7557	100
◇	White	7558	100

Waterproof isolation gown



Description: Waterproof gown with long sleeves, length 115cm, elastic cuffs in Jersey, waist and collar laces

Bags of 10 units

Content: PE + Non sterile non woven PP spunbond, extra soft and antistatic treatments, for single use

Weight: PE 15gsm + PP 25gsm

Compliance: European Directive 93/42/CEE (class I)
EN13795

	Size	Ref	Packaging
◇	Adult	7559	100



Headwear

- ◆ Products intended to patients, nursing as well and medical and surgical staff
- ◆ Light, airy and captivating material to maximise comfort in the event of a prolonged use
- ◆ Complete range of products fitting all use and processes in clinics / hospitals
- ◆ Compliant to European Directive 93/42/CEE (class I)

Mob cap with clip

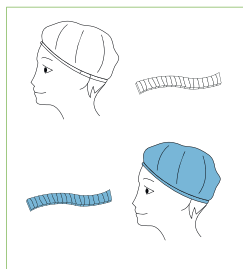

Description

Mob cap with clip, light and airy for single use
Clip with elastic

Bags of 100 mob caps

Content

Non sterile non woven PP spunbond, extra soft and antistatic treatments

Weight: 12gsm

Size	Ref	Packaging
◇ Unique	7047	1000
◆ Unique	7047B	1000

Cap



Description

Cap, light and airy for single use

Dispenser box of 100 caps

Content

Non sterile non woven PP mesh ventilated, extra soft and antistatic treatments

Weight: 25gsm

Size	Ref	Packaging
◆ Unique	7054	600

Surgical cap



Description

Surgical cap, light, airy and captivating, with two links to be tied up around the neck, for single use

Dispenser box of 100 surgical caps

Content

Non sterile non woven PP mesh ventilated, extra soft and antistatic treatments

Weight: 25gsm

Size	Ref	Packaging
◆ Unique	7058	600

Doctor cap



Description

Doctor cap, light and airy, for single use

Dispenser box of 100 doctor caps

Content

Non sterile non woven PP mesh ventilated, extra soft and antistatic treatments

Weight: 25gsm

Size	Ref	Packaging
◆ Unique	7063	600



Footwear

- ◆ Products intended to patients, nursing as well and medical and surgical staff
- ◆ Compliant to European Directive 93/42/CEE (class I)

PP Shoe covers



White
Not waterproof

Bulk products

30gsm

Size	Ref	Packaging
38x18cm	7046	500

CPE shoe covers



Blue
Waterproof

Bags of 100 units

PE 20Mi

Size	Ref	Packaging
36x15cm	7051	2000

Non-slip shoe covers



Bi-colour
Waterproof

Bulk products

PP 30gsm

PE 50Mi embossed

Size	Ref	Packaging
38x18cm	7049B	400

Slippers with shoe covers



Blue
Not waterproof
Soles in EVA

Individually packed
(by pair)

20gsm

Size	Ref	Packaging
38cm	7074	250 pairs

Non-slip socks



Grey

Polyester-cotton

Bags of 10 pairs

Size	Ref	Packaging
40x10cm	7088	200 pairs

Slippers



White
Soles in CPE
covered with PP

Individually packed
(by pair)

Size	Ref	Packaging
38cm	7079	250 pairs



Gloves

Our medical gloves are designed in the strict respect of European Directives for medical devices, notably the EN455 framing the tightness, physical properties, the bio-compatibility and the shelf life of the gloves. Our products range ensures the highest level of quality and security.

Powder-free nitrile

Description

Same touch and feeling than latex, ultra-elastic and very good dexterity
Excellent grip under humid and dry conditions thanks to textured fingers

Uses

Nursing care, handling blood, chemical products, food and for quick household chores



Size	Box	Packaging
XS	200	2000
S	200	2000
M	200	2000
L	200	2000
XL	200	2000

Powder-free vinyl

Description

Average elasticity, good dexterity
Smooth appearance providing appropriate touch and grip
Waterproof and airtight
Cannot be use for handling chemical products and fatty food

Uses

Handling non-fatty food and for quick household chores



Size	Box	Packaging
S	100	1000
M	100	1000
L	100	1000
XL	100	1000



Gloves

Our medical gloves are designed in the strict respect of European Directives for medical devices, notably the EN455 framing the tightness, physical properties, the bio-compatibility and the shelf life of the gloves. Our products range ensures the highest level of quality and security.

Powder-free Latex

Description

Same touch and feeling than latex,
ultra-elastic and very good dexterity
Excellent grip under humid and dry
conditions thanks to textured fingers



Uses

Nursing care, handling blood,
chemical products, food and for
quick household chores



Size	Box	Packaging
XS	200	2000
S	200	2000
M	200	2000
L	200	2000
XL	200	2000

SURGICAL GLOVES

Description

Average elasticity, good dexterity
Smooth appearance providing
appropriate touch and grip
Waterproof and airtight
Cannot be use for handling chemical
products and fatty food



Size	Ref	Box	Packaging
S	0001	100	1000
M	0002	100	1000
L	0003	100	1000
XL	0004	100	1000



Face masks

Description

Surgical mask high filtration
3 plies, hypoallergenic
Anti-vapor nasal barette
Latex and fiberglass free
Non sterile, for single use

Packaging

Dispenser box of 50 masks
Carton of 20 boxes (1000 masks)

Compliance

European requirements of EN14683



Surgical masks type II



Fixation by elastics

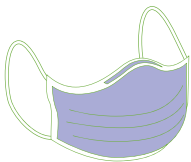

Ref: 7015C

Fixation by bonds

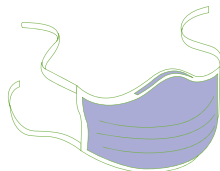

Ref: 7015R

Surgical masks type IIR



Fixation by elastics

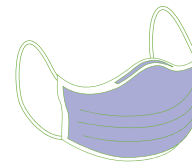

Ref: 7016

Fixation by bonds

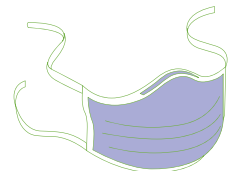

Ref: 7016R

Recommended for surgery

Content

1st pli in high filtration PP, 2nd pli in Melt Blown, 3rd pli in PP ou SMS (attention)
Latex and fiberglass free

Technical features

Bacterial Filtration Efficiency up to 98%
Differential pressure* < 29.4
Perfect sealing

* Measured in Pascal

** Measured in mm of mercury

Content

1st pli in high filtration PP, 2nd pli in Melt Blown, 3rd pli in PP ou SMS (attention)
Latex and fiberglass free

Technical features

Bacterial Filtration Efficiency up to 99,8%
Differential pressure* < 49.0
Splash resistance pressure ** > 120
Optimal bacterial filtration, resistance to liquids



Other protections

Apron



Description

Embossed apron 120x90cm

Content

PE (refer to table below for more details)

Ref	Content	Bag	Packaging
◇ 7041	25 micron	100	1000
◆ 7042	25 micron	100	1000
◇ 7043	40 micron	100	500

Bib



Description

Waterproof and resistant bib

Content

1 face wadding paper 20g, 1 face PE 15g

Grammage

35gsm

Size	Ref	Bag	Packaging
70x37cm	7087	100	900

Coverall



Description

Coverall with hood, zipper at front, elasticated ankles, cuffs and hood
Use against minor risks and dirt without chemical products

Content

Non sterile non woven PP spunbond, extra soft and antistatic treatments, for single use

Weight

40gsm

Size	Ref	Bag	Packaging
L-XL	7040	1	25



Bedding protection



Nateen offers a wide range of non woven single use Bedding Protection items, designed for health-care institutions. This products range includes notably:

- ◆ Pillowcases
- ◆ Fitted sheets
- ◆ Flat sheets
- ◆ Draw sheets
- ◆ Bed covers
- ◆ Transfer sheets
- ◆ Bedding kits

Nateen sales team remain at your disposal to design tailor made individual / bedding kits suitable for your needs and processes.



Bedding protection

Pillowcase



Description

White pillowcase 65x65cm with a 10cm flip

Content

Non sterile non woven PP spunbond, extra soft and antistatic treatments, for single use

Weight: 25gsm

Size	Ref	Bag	Packaging
65x65+10cm	4022	50	200

Fitted sheet



Description

White fitted sheet size 90x200cm for single bed protection

Content

Non sterile non woven PP spunbond, extra soft and antistatic treatments, for single use

Weight: 25gsm

Size	Ref	Bag	Packaging
90x200cm	4020	10	50

Bed sheet



Description

White bed sheet to cover the patient

Content

Non sterile non woven PP spunbond, extra soft and antistatic treatments, for single use

Weight: 25gsm



Size	Ref	Bag	Packaging
90x200cm	4024	10	100
140x240cm	4019	10	100





Bedding kit

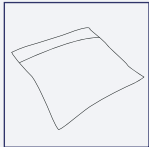
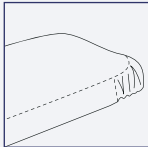

Standard ECO bedding kit

	Pillowcase	Fitted sheet single bed	Bed sheet 140x240cm
			
	Ref: 4022	Ref: 4020	Ref: 4019
		Ref	Weight
1 kit by polybag		4023	25gsm
			Packaging
			50

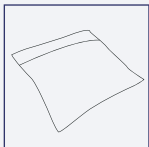
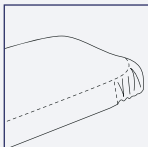
Premium bedding kit

	Pillowcase	Fitted sheet 100x200cm	Bed sheet 130x230cm
			
	Ref: 4022	Ref: -	Ref: -
		Ref	Weight
1 kit by polybag		4023A	40gsm
			Packaging
			50



Bedding protection

Plasticised draw sheet

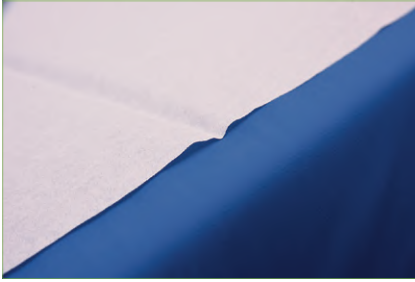

Description

Plasticised draw sheet for bedding protection

Content

Cellulose 20gsm + PE 35gsm

	Size	Ref	Bag	Packaging
◆	80x210cm	4028	25	100
◇	80x210cm	4028B	25	100

Transfer sheet



Description

Transfer sheet to cover and transfer patients to surgery
Products for health-care institutions and for firefighters
Carrying capacity up to 130kg

Content

Non sterile non woven PP spunbond, extra soft and antistatic treatments, for single use

Weight: 65gsm

	Size	Ref	Bag	Packaging
◇	90x210cm	4032	1	50
◇	160x210cm	4017	1	50

Bed cover



Description

Blue cover bed

Content

External: non sterile non woven PP spunbond, extra soft and antistatic treatments
Internal: polyester

Weight: External: 25gsm, Internal: 120gsm polyester

	Size	Ref	Bag	Packaging
◆	160x220cm	4030	1	20



Airways tubing & Nebulizers

Soft touch nasal cannula

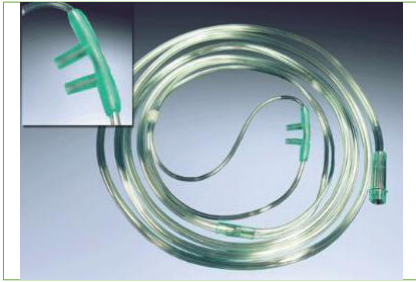

Standard - Soft - Super Soft Touch Nasal cannula
Wide range of tubing, prong, cannula for help to minimize irritation and soreness.
Available in variety of patient sizes and crush-resistant tubing lengths. 6P Free or 16P free.
Available in different colors – Blue , Green or transparent tubing.
ISO-10993 Bio compatibility standard.

CO₂ /O₂ nasal cannula

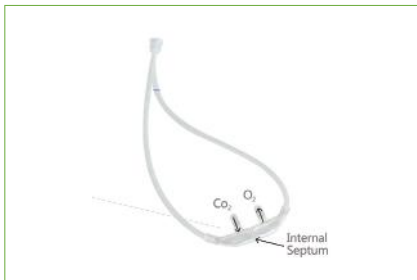

CO₂/O₂ nasal cannulas for monitoring expired gases from one nare while delivery O₂ through the other.

Oxygen Mask



Made of clear, medical grade PVC, with adjustable nose clip, elastic strap.
Medium concentration, approx 50%.
Color : green transparent, white transparent, light blue transparent.
Available with 7' anti-crush tubing, the length can be customized.
Packing: individual package, 50pcs/carton or 100 pcs/ carton.

Non Rebreathing Mask



Made of clear, medical grade PVC, with reservoir bag.
With Adjustable nose clip, elastic strap with/without latex.
Color: green transparent, white transparent, light blue transparent.
Available with 7' anti-crush tubing, the length can be customized.
Packing: individual package, 50pcs/carton or 100 pcs/carton.

Nebulizer kit and Nebulizer



Made of clear, medical grade PVC.
Available with T-piece and mouthpiece or corrugated mouth piece.
Available with 7' anti-crush tubing, the length can be customized.
Packing: individual package, 50pcs/carton or 100 pcs/ carton.
Different type of nebulizer jars are available.



Disinfecting towel



Ultra Sound Wipes



Surface Cleaner&Disinfectant



Veti Pro+ Surface & Desinfecting Wipes



Alcohol fomulation Sanitizing & disinfection Wipes



Dermatological products for babies



Diaper Cream

Description : Smooth and shiny white cream with characteristic odour of raw materials

Content : aqua (water), caprylic/capric triglyceride, zinc oxide, isopropyl myristate, glycerin, olea europaea (olive) fruit oil, peg-30 dipolyhydroxystearate, propanediol, magnesium sulfate, panthenol, bisabolol, magnesium stearate, gluconolactone, calcium gluconate, sodium benzoate

Capacity : de 10 à 1000 ml



Oleocalcaire Liniment

Description : Beige soft paste with a base odour

Content : aqua (water), helianthus annuus (sunflower) seed oil*, glyceryl stearate, olea europaea (olive) fruit oil*, cera alba (bees-wax), calcium hydroxide

Capacity : de 10 à 1000 ml



Cleansing Gel Body & Hair

Description : White foaming gel with characteristic odour of perfume floral, powdery with musked notes

Content : aqua (water), glycerin, sodium lauroyl glutamate, lauryl glucoside, coco-glucoside, cocamidopropyl betaine, parfum (fragrance), glyceryl oleate, allantoin, olea europaea (olive) fruit oil, tocopherol, hydrogenated palm glycerides citrate, acrylates/c10-30 alkyl acrylate crosspolymer, styrene/acrylates copolymer, propylene glycol, polyquaternium-10, tetrasodium glutamate diacetate, citric acid, sodium benzoate

Capacity : de 10 à 1000 ml



Dermatological products for babies



Cleansing Milk

Description : White emulsion with characteristic odour of perfume floral, powdery with musked notes

Content : aqua (water), helianthus annuus (sunflower) seed oil, glycerin, glyceryl stearate, glyceryl stearate citrate, hydrogenated coconut oil, propanediol, olea europaea (olive) fruit oil, pentylene glycol, tocopheryl acetate, allantoin, parfum (fragrance), polyacrylate crosspolymer-6, caprylyl glycol, ethylhexylglycerin, tetrasodium glutamate diacetate, citric acid.

Capacity : 500 ml



Dermatological products for adults



Diaper Cream

Description : Smooth and shiny white cream with characteristic odour of raw materials

Content : aqua (water), caprylic/capric triglyceride, zinc oxide, isopropyl myristate, glycerin, olea europaea (olive) fruit oil, peg-30 dipolyhydroxystearate, propanediol, magnesium sulfate, panthenol, bisabolol, magnesium stearate, gluconolactone, calcium gluconate, sodium benzoate

Capacity : de 10 à 1000 ml



Shower Gel

Description : Frosted foaming gel, colorless to slightly yellow, with characteristic odour of perfume flowerly, fruity and woody

Content : aqua (water), ammonium lauryl sulfate, glycerin, cocamidopropyl betaine, decyl glucoside, cocoglucoside, parfum (fragrance), panthenol, polyquaternium-10, acrylates/c10-30 alkyl acrylate crosspolymer, tetrasodium glutamate diacetate, citrus aurantium dulcis (orange) fruit extract, citrus limon (lemon) fruit extract, citrus paradisi (grapefruit) fruit extract, sodium chloride, citric acid, sodium hydroxide, sodium benzoate, potassium sorbate, hexyl cinnamal, limonene, benzyl salicylate, linalool, hydroxy-citronellal.

Capacity : de 10 à 1000 ml

Shea Hand Cream

Description : White viscous emulsion with characteristic odour of perfume Karite hypo

Content : aqua (water), glycerin, butyrospermum parkii (shea) butter, cera alba (beeswax), cetearyl alcohol, cyclopentasiloxane, cetearth-20, parfum (fragrance), stearic acid, palmitic acid, carbomer, tocopheryl acetate, diphenyl dimethicone, caprylyl glycol, decylene glycol, potassium sorbate, triethanolamine

Capacity : de 15 à 250 ml



Dermatological products for adults



Moisturizing Body Milk

Description : Thick emulsion without colouring and fragrance

Content : aqua (water), glycerin, olea europaea (olive) fruit oil, cetearyl alcohol, cera alba (beeswax), cyclopentasiloxane, cetearth-20, glycyrrhethinic acid, tocopheryl acetate, stearic acid, palmitic acid, diphenyl dimethicone, carbomer, caprylyl glycol, triethanolamine, potassium sorbate.

Capacity : de 10 à 1000 ml



Oleocalcaire Liniment

Description : Beige soft paste with a base odour

Content : aqua (water), helianthus annuus (sunflower) seed oil*, glyceryl stearate, olea europaea (olive) fruit oil*, cera alba (beeswax), calcium hydroxide

Capacity : de 10 à 1000 ml





ADULT CARE

by *nateen*[®]

ECONOMIC LINE

This line has been created for light use and a price sensitive market. However, the NATEEN®'s quality standards can be found in this range include ADL, Leak Guards, High Quality Gel, Odour Control, Refastenable Tapes (for diapers), which can all be found at competitive market prices.

COMBI
(BRIEF)



- ORANGE 💧 1200 ml (40.56 oz)
- BLUE 💧 1400 ml (47.32 oz)
- PURPLE 💧 1600 ml (54.08 oz)

packing
8 bags of 10 pcs
4 bags of 25 pcs

S 65 – 105 cm | 26"-42" L 115 – 150 cm | 46"-60"
M 95 – 125 cm | 38"-50"

FLEXI
(PULL-UP)



- BLUE 💧 1400 ml (47.32 oz)
- PURPLE 💧 1600 ml (54.08 oz)

packing
8 bags of 10 pcs
4 bags of 25 pcs

S 65 – 105 cm | 26"-42" L /XL 110 – 170 cm | 44"-67"
M 90 – 130 cm | 36"-52"

MATI
(UNDERPAD)

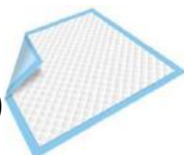

- ORANGE 💧 230 ml (24,68 oz)

packing
8 bags of 10 pcs
1 case of 100 pcs

M 60X60 cm | 24" 24"
L 60X90 cm | 24" 36"

ADULT CARE

by *nateen*[®]

PREMIUM LINE

FLEXI
(PULL-UP)







	SOFT		1600 ml (54,1 oz)
	PLUS		2300 ml (77,8 oz)
	MAXI		3300 ml (111,6 oz)

 packing
8 bags of 10 pcs

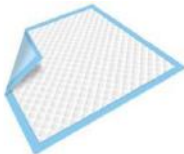
	M	90 – 130 cm		36"-52"	XL	130 – 170 cm	50"-67"
	L	110 – 170 cm		44"-67"			

MATI
(UNDERPAD)



	SOFT		700 ml (23,7 oz)
	PLUS		900 ml (30,4 oz)

 packing
8 bags of 10 pcs

	S	40X60 cm		16" 24"	L	60X90 cm		24" 36"
	M	60X60 cm		24" 24"	XL	180X80 cm		71" 31"

EASY-8
(SHAPED PAD)



	SOFT		1100 ml (37,2 oz)
	SUPER SOFT		1400 ml (47,3 oz)
	PLUS		1700 ml (57,5oz)
	SUPER PLUS		2000 ml (67,6 oz)
	MAXI		2450 ml (82,8 oz)
	ULTRA		3050 ml (103,1 oz)
	SUPER ULTRA		3650 ml (123,4 oz)

 packing
8 bags of 10 pcs

+ PANTI
(MESH PANT)



All our EASY-8 fit with the use of a PANTI (Mesh Pant). The PANTI can be used several times and washed. We offer two range of quality for longer use. Both range can be order for SMALL, MEDIUM, LARGE, XL and XXL.



ADULT CARE

by *nateen*[®]

COMBI
(DIAPER)



	SOFT		1500 ml (50,7 oz)
	SUPER SOFT		2000 ml (67,6 oz)
	PLUS		2500 ml (84,5oz)
	SUPER PLUS		2800 ml (94,7 oz)
	MAXI		3200 ml (108,2 oz)
	ULTRA		4000 ml (135,3 oz)
	SUPER ULTRA		5500 ml (186,0 oz)

packing
8 bags of 10 pcs



S 65 – 105 cm | 26"-42"
M 95 – 125 cm | 38"-50"

L 115 – 150 cm | 46"-60"
XL 130-175 cm | 52"-69"

ADDITIONAL PRODUCTS

WET
WIPES



20x30 cm

packing
12 bags of 40 pcs

SANITARY
NAPKINS





BABY CARE

by **nateen**[®]



Air fresh



Chlorine and fragrance free



Perfect fit



Leak proof

BABY CARE is a full range of premium baby nappies aiming to offer the latest innovation in the sector in order to provide customers with high quality standards at the right price. Our attractive design is our final touch that make the difference.

PREMIUM LINE

NAPPY



NB

< 10lbs
< 5kg



8 x 20 pcs
2 x 80 pcs

S

7-13 lbs
3-6 kg



8 x 20 pcs
2 x 80 pcs

M

9-20 lbs
4-9 kg



8 x 18 pcs
2 x 72 pcs

L

15-40 lbs
7-18 kg



8 x 16 pcs
2 x 64 pcs

XL

26-55 lbs
12-25 kg



8 x 14 pcs
2 x 56 pcs

HIGH ABSORBENCY

BREATHABLE

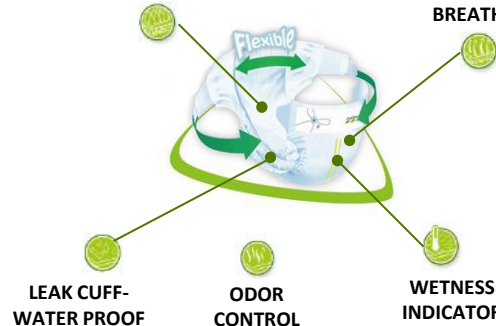

PULL UP



M

13-22 lbs
6-10 kg



8 x 20 pcs

L

20-31 lbs
9-14 kg



8 x 20 pcs

XL

26-38 lbs
12-25 kg



8 x 20 pcs

XXL

>33 lbs
>15 kg



8 x 20 pcs



BABY CARE

by **nateen**[®]

SOFT LINE

NAPPY



2

< 10lbs
< 5kg



24 pcs

3

9-20 lbs
4-9 kg



22 pcs

4

15-40 lbs
7-18 kg



20 pcs

5

26-55 lbs
12-25 kg



18 pcs

6

>55 lbs
> 25 kg



12 pcs

ADDITIONAL PRODUCTS

WET WIPES



10 x 1 pcs

or 1 x 80pcs



BREAST PAD



36 pcs
Super absorbent
Double adhesive tape



nateen

Medical Division

